

Exposure zones

It is important to understand the windloadings of where you are situated in the UK to ensure that your roofing conforms to the correct sealing requirements.

In order to determine the degree of exposure where your structure will be situated, please examine the map on the right.

For buildings that stand above their surroundings (meaning that they have no windshields such as trees or hills due to being in a large open area), Briarwood recommend that the structure must be considered subject to severe exposure.

To understand whether your structure is in an area where it may be subject to severe exposure, the following can help determine the surrounding environment and whether it would meet the classification:

- Near the coast
- On a hill where the structure rises above the general level of trees
- Towards a cliff-face
- On the side of a valley
- On high ground

Due to the sheeting being fixed through oversized holes in the crest corrugations, they can't be used in a stressed skin construction and can't be assumed to provide lateral restraint to the top flange of a purlin.

The maximum purlin deflection under total serviceability loads for steel structures should not exceed the following formula: $\frac{\text{purlin span}}{220}$

IMPORTANT NOTICE* For buildings which stand in surroundings where it is in open country with no windbreaks (especially including sites located near the coast, on the top of hills), Briarwood recommend that the specifier and designer contact us as their structure may be subject to severe exposure.

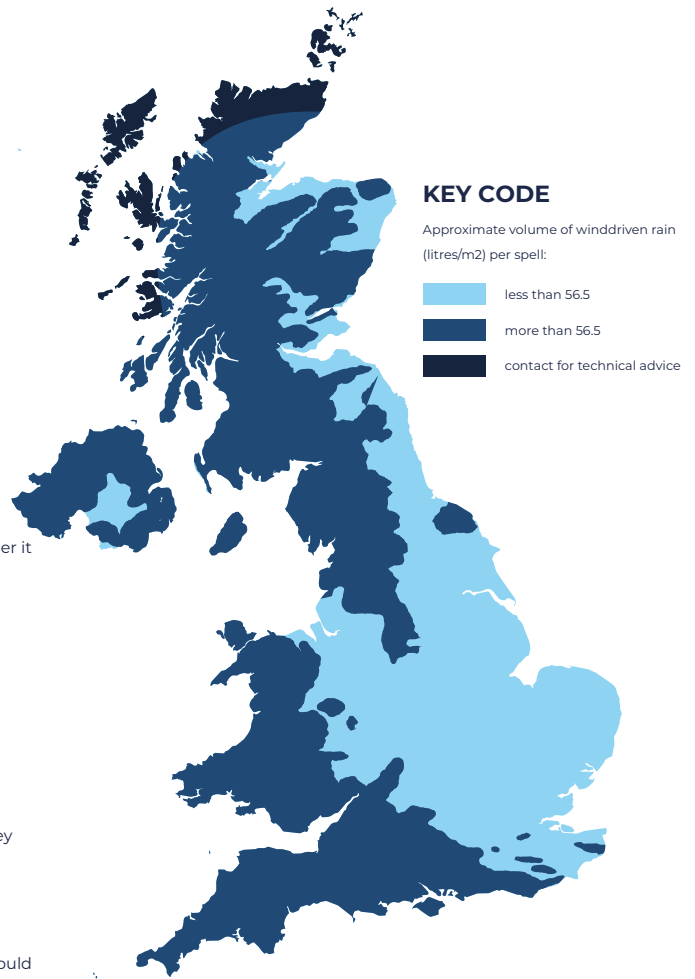

Wind loading must be calculated in accordance with BS EN 1991 Eurocode 1: Actions on structures - Part 1-4: General actions - Wind actions.

PURLIN CENTRES

Briarwood recommend two fixings per sheet per purlin to support the fibre cement sheet to the structure. Our EUROSIX maximum purlin centres is 1375 mm for imposed loads of up to 1.89kN/m2.

In some areas, wind suction loading may exceed the requirements set above in relation to wind exposure; please contact our technical department to help provide advice and guidance for reduced purlin spacing.

When using our fibre cement sheets to clad your structure, the maximum rail spacing should not exceed 1825 mm for imposed loads of up to 1.07kN/m2.

It may be required to reduce the purlin rail spacings to facilitate extra fixings to deal with high wind loads.

IMPORTANT* There should be a maximum of 6 fixings per sheet (which will equvalate to 2 fixings per purlin per sheet.

If you need to reduce the purlin spacings, you must ensure that the sheet lengths only span across three purlins. If your sheet spans across more than 3 purlins, then you will need to use shorter lengthed sheets. By doing this, it will help with wind suction.

Lap treatments

WHAT IS LAP?

The lap is the measurement that describes what area and how much of one sheet overlaps onto another sheet at each end. This is split into the end lap, and the side lap.

ROOF PITCHES

The minimum pitch for our EUROSIX fibre cement sheeting is 5°.

When the fibre cement sheets are sloped on a pitch between 5° and 10°, it is recommended that the maximum slope length should be no more than 15 metres, and that they have double sealed end laps and single sealed side laps.

For roofs over a 10° pitch (and where there may be periods where large build-up of snow occurs), it is recommended that 300mm double sealed end laps and single sealed sidelaps are used.

SEALING THE ROOF SHEETS

Briarwood recommends to use a 8 mm diameter mastic butyl strip where the adhesive allows the overlapped fibre cement sheets to bond together whilst still allowing movement for the expansion of the

These diagrams show the end lap detail for a 15° roof pitch.

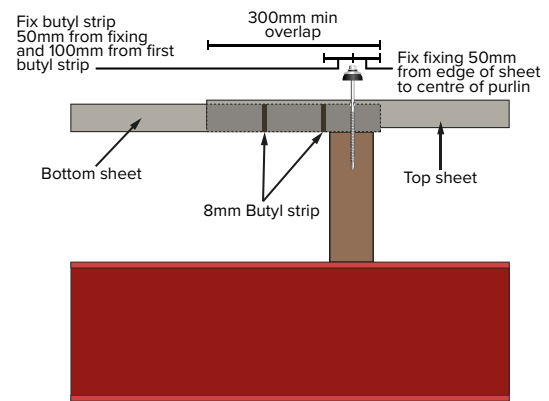
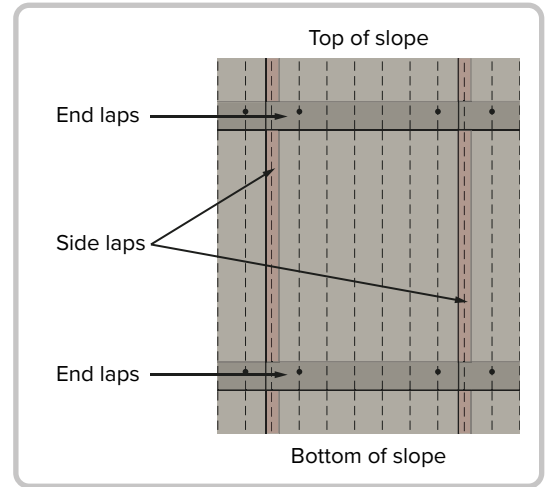
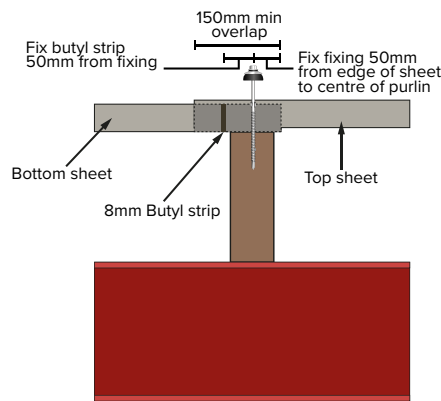

LAP AND SEAL TABLE

For ease, Briarwood have compiled two tables (which can be found on the right) to help reference alongside the UK map on the previous page in order to decipher what level of wind exposure your structure will be subject to.

Within this information, you will be able to find out what roof pitches require the different minimum end laps, as well as how the end laps and side laps must be treated to ensure that your structure is well designed when in an area in moderate or severe sites.

SHELTERED TO MODERATE SITES

LESS THAN 56.5 L/M2 OF WIND-DRIVEN RAIN PER SPELL

MINIMUM ROOF PITCH	≥22.5°	≥17.5°	≥15°	≥15°	≥10°	≥5°
Minimum end laps	150 mm	150 mm	300 mm	150 mm	150 mm	300 mm
End laps treatment	Unsealed	Unsealed	Unsealed	Sealed	Sealed	Double sealed
Side laps treatment	Unsealed	Unsealed	Unsealed	Unsealed	Sealed	Unsealed

MODERATE TO SEVERE SITES

MORE THAN 56.5 L/M2 OF WIND-DRIVEN RAIN PER SPELL

MINIMUM ROOF PITCH	≥22.5°	≥17.5°	≥15°	≥10°	≥5°
Minimum end laps	150 mm	150 mm	150 mm	300 mm	300 mm
End laps treatment	Unsealed	Sealed	Sealed	Sealed	Double sealed
Side laps treatment	Unsealed	Unsealed	Sealed	Sealed	Sealed

Setting out the roof

BEFORE CARRYING OUT THE WORK

Before all work is commenced, the structure must be checked to make sure that all supporting purlins and side rails are the correct level and spaced correctly according to the relevant purlin centres table. You must also ensure that all components are securely fixed and have the correct amount of torque.

LAYOUT OF THE SHEETING

The first and last sheets laid on any slope have no mitres and remain whole.

To correctly install, work one column at a time and lay the fibre cement sheets from the eaves to the ridge. Ensure that the prevailing wind direction matches the side lap.

An opposing column approach is taken for roofs that have a duo pitch and the sequence needed to ensure the cranked ridge fitting is correctly located can be found below.

Do not fit the roofing sheets on an apex roof where you start by laying down one full slope, and then onto the other slope. This will cause an issue when fitting the ridges because there may be a variation in the tolerances of the fibre cement sheeting and ridges. Doing this will increase the chance of the ridges not fitting correctly.

It is important that all of the sheets line up in straight lines up and over each slope of the roof to ensure that the ridge fittings can be fixed correctly.

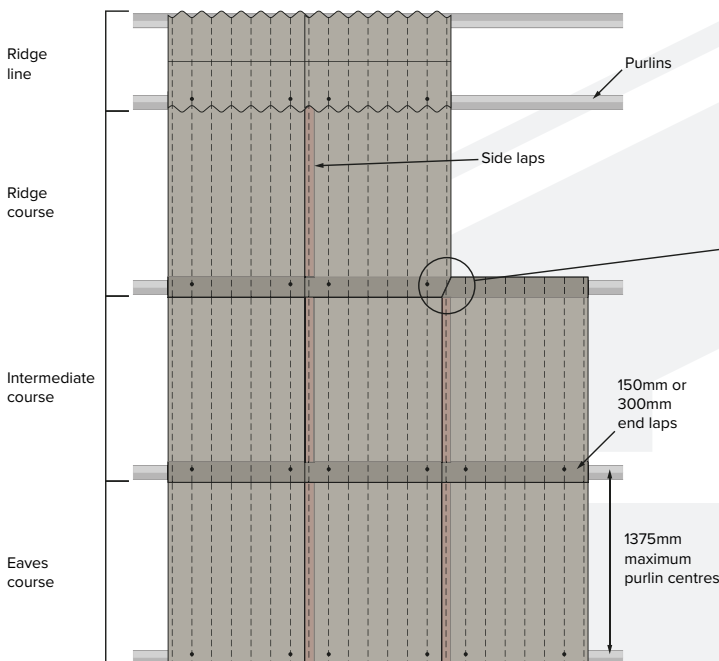
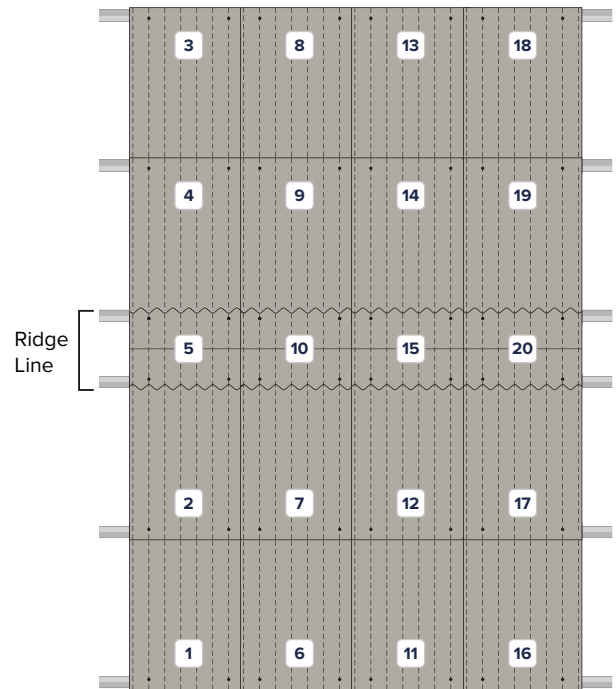
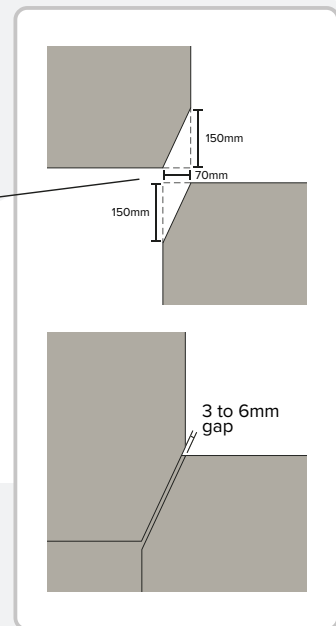

Diagram showing 1525mm EUROSIX fibre cement sheets

VISUAL REPRESENTATION OF MITRE



Mitring

To ensure that all fibre cement sheets lay in the same plane, it is required that two of the sheets at each junction is mitred at the corners which will avoid four layers of sheets stacking.

The mitres should be cut 150 mm (or up to 300 mm depending on the overlap) up the vertical edge of the corner, and then 70 mm along the horizontal edge.

Briarwood recommend that the gap between the mitres should be 3 to 6 mm.

The mitred joint is covered on the top and the bottom by the two other fibre cement sheets which allows the sheets to be fixed ensuring that the product is weatherproof and unseen.

IMPORTANT RULES

DO NOT MITRE ON THE ROOF

Prior to the fibre cement sheeting being raised onto the roof, you must always ensure that the layout has been chosen and that the appropriate sheets have been mitred on the ground level with no other product on the underneath. By mitring on the ground level on an even surface (such as a bench) and with no product underneath, this eliminates the chance of damaging other products and/or accidentally mitring the layered sheets once installed. Another primary reason on why you would not mitre on the roof is because this stops the dust and lime bloom from spreading across the sheets; this is the main cause for efflorescence to occur on the roofing sheets. If you mitre not following our guidance, it will increase the chance of potential damage and faults occurring which will invalidate any warranties and guarantees.

USE THE CORRECT EQUIPMENT

Briarwood recommend the use of a reciprocating saw in order to mitre the fibre cement sheets. We do not recommend that you use a handsaw or angle grinder because of the pressure which can build up whilst cutting through the sheet.

SHEET OVERLAPPING

To reduce the overlapping of four roof sheets, the corners of two must be mitred. The angle and size of the mitre is governed by the profile of the sheet and the end and side lap dimensions. It is recommended that a good quality butyl mastic strip is involved in joining the overlapping sheets to provide a weathertight seal.

MITRING LAYOUTS

For guidance on mitring for single and double slope roofs, see the images on this page to reference on how the mitring layout would appear.

For a double slope roof with adjustable ridges, one slope must be laid left to right and the other must be laid right to left.

Please bear in mind that when cranked crown ridges are used on the structure, both top sheets on either side of the slope must be mitred (as well as the cranked crowns).

For structures using 2 piece adjustable ridges, the top sheets on either side of the slopes and ridges must not be mitred.

Tel: +44 (0)1934 641446
sales@briarwoodproducts.co.uk
www.briarwoodproducts.co.uk

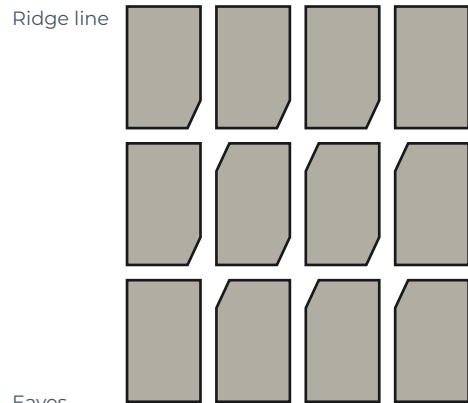

Laid left to right →

Mitres must be on the opposite hand when laying right to left

This mitring plan is designed for a mono pitch roof.

Laid right to left →

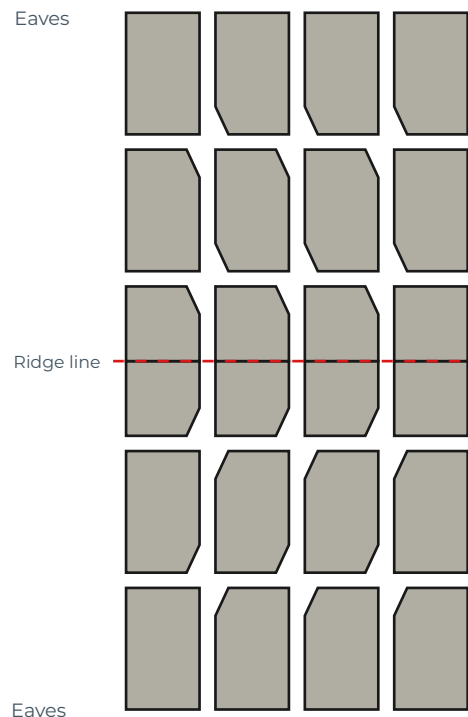

Laid left to right →

Mitres must be on the opposite hand when laying right to left

This mitring plan is designed for a duo pitch roof.

Poor mitring accounts for 95% of all roof leaks after installation, it is therefore paramount that the mitring process occurs and follows suit according to our advice and guidance set out by Briarwood.

Fixing

All fibre cement sheeting should be fixed accordingly to the structure inline with the BS 8219 standard.

When fixing a fibre cement roof sheet onto a structure, there must only ever be two fixings per sheet per purlin. There should only ever be a maximum of 6 fixings per sheet because then this would account for 2 fixings per purlin per sheet. If the fibre cement sheets spans more than three purlins, we recommend that you use smaller lengths and span only two purlin spaces maximum.

Depending on the type of purlin used on the structure will also depend on what type of fixing you use; therefore this must be recognised at the early stages of the design of the structure.

Choosing the right fixing at the start is important to avoid the chance of leaks, product failure and corrosion.

Fixings must not be less than 50 mm from the edge of any fibre cement product.

If you would like to learn more information about the fixings which you have chosen to use to secure the fibre cement sheeting onto the purlins, please contact our technical office.



TOP-FIX/SELF-TAPPING

It is recommended that a self-drilling top-fix screw is adopted. This simple operation offers a fast, low cost fixing solution. Using the correct fixing with reamer wings on the shank, you are creating the perfect and ideal fixing environment. If the steel top fixings are used (without reamer wings), the hole must be pre-drilled at least 2 mm larger than the fixing diameter. These are available for timber, light section and heavy section purlins.

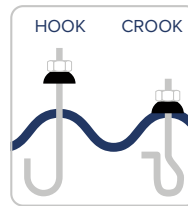

HOOK AND CROOK BOLTS

Hook and crook bolts are commonly used to secure sheets. Clearance holes should be 2 mm larger than the fixing, and must be pre-drilled to accept the fixing. The appropriate washer must be used to seal the operation to ensure that the fixing keeps the hole watertight and weathertight.

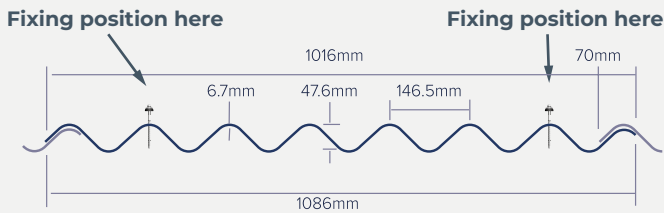

FIXING POSITION

The diagram shows specifically the recommended fixing positions. Never fix through side lap detail, always through first full corrugation, as per the diagram.

FASTENER SIZES

PURLIN TYPE	LENGTH	DIAMETER
TIMBER	130 mm	6.5 mm
TIMBER	180 mm	6.5 mm
LIGHT SECTION	105 mm	6.5 mm
HEAVY SECTION	110 mm	6.5 mm



DON'T USE A HAMMER

Never hammer fixings through the roof sheet. This will invalidate the guarantee on the product because the fibre cement sheets will shatter under impact and subsequently allow water to penetrate the apparent fixing.

Briarwood recommend that you should always pre-drill where the desired fixings will go on the fibre cement sheets.



NEVER WALK ON THE SHEETS

Never walk directly on-top of the fibre cement sheets. When you install the fibre cement sheets or when it is necessary to get ontop of the structure, you must use crawling boards or ladders. It is never advisable to wear soft soled shoes and you must never walk on liner panels. Foot traffic on the sheets should be kept to a minimum (both on the laid and on the ground).

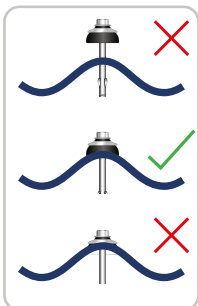

ENSURE THE FIXINGS ARE WEATHERTIGHT

To achieve a watertight and weathertight seal, it is important to confirm that the sealing washer is correctly tightened. This means that the fixing is not over-tight, nor is it too-loose. After a period of time when the material has settled, the fixings may need to be re-tightened with hand tools.

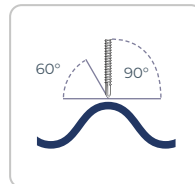

PRE-DRILLING FIXING HOLES

Using a tungsten carbide tipped drill at a 90° angle to the sheet, drill a hole 2 mm larger than the selected fixing diameter. Always drill at the 'apex corrugation' of the side of a profile. You must never fix a sheet in the 'valley' or a 'slope' of the profile.

Vertical cladding

TOPFIX METHOD

When using topfix fasteners to fix vertical sheeting, the weight of the sheets requires additional support to prevent the sheet from sagging down and overstressing both the sheet and the fasteners.

To support the base of each sheet, support clips that hook over the sheeting rails should be used.

Please reference diagram Fig.1

VALLEY FIXING METHOD

This is an alternative fixing method that does not require the support clips to fix the sheets through the valley corrugations.

The fasteners should be positioned (as per Fig.2) with a 2 mm oversize hole pre-drilled through the sheet.

Briarwood recommend the following fasteners which are suitable for valley fixing the EUROSIX fibre cement sheets:

- Hot rolled rails require SD12-T15-5.5 x 70 together with BAZ washers
- Cold rolled rails require SD3-T15-5.5 x 60 together with BAZ washers
- Timber rails require TDC-T-T16-6.3 x 76 together with BAZ washers (drill a pilot hole in the timber rail)

Fig.1

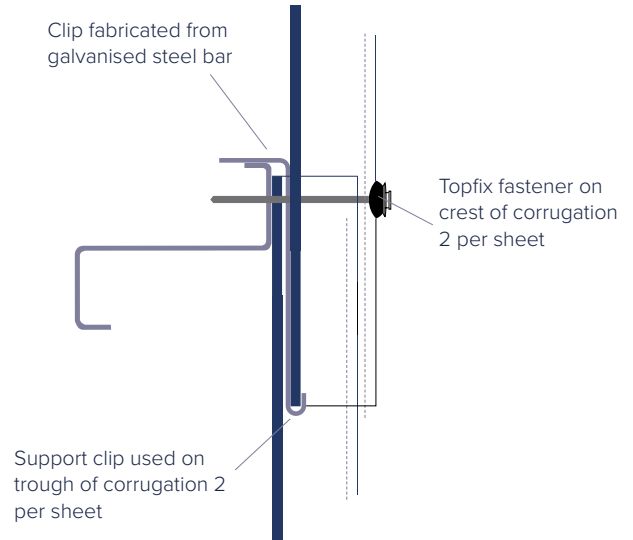

Fig.2

